

SOCKELLEISTEN SKIRTING BOARDS

Aluminium und Edelstahl

Aluminium and stainless steel



Prinz

Starke Verbindung
Kluge Technik
Strong contacts
Clever technology



Inhalt

Content

Sockelleisten aus Aluminium und Edelstahl Skirting boards from aluminium and stainless steel

Aluminium-Clips-Sockelleisten · Aluminium clip skirting boards.....	3 – 5
Aluminium LED-Sockelleisten · Aluminium LED skirting boards.....	6
Zubehör · Accessories.....	7
Aluminium-Winkel-Sockelleisten · Aluminium angle skirtings.....	8 – 10
Aluminium Hohlkehrl-Sockelleisten · Aluminium cove and cap skirtings.....	11
Aluminium Reno-Sockelleisten · Aluminium renovation skirtings.....	12
Aluminium Flachprofile · Aluminium flat sections.....	13
Aluminium-Sockelleisten mit Einschub · Aluminium skirting boards with slide in-unit.....	14 – 15
Abgewinkelte Aluminium-Sockelleisten · Angled aluminium skirting boards.....	16 – 17
Aluminium-Sockelprofile · Aluminium skirting sections.....	18
Edelstahl-Sockelleisten · Stainless steel skirting boards.....	18



359 10 x 60 mm

Aluminium-Clips-Sockelleiste

Aluminium.
Bodenabdeckbreite 10 mm.
Inklusive Clips (2,5 Stück/m).
Auf Anfrage biegsam.

Aluminium clip skirting board

Aluminium.
Floor covering width 10 mm.
Clips included (2,5 clips/m).
Bendable on request.

r ≥ 30 cm

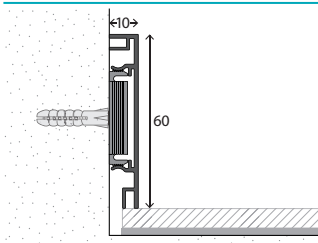
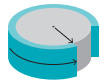

Farbe / colour	cm	SB	Art. Nr. / item no	EAN-Code	VE
silber / silver	400		359 10 11 400	4012406 29787 4	40 m
schwarz / black (RAL 9005)	400		359 10 32 400	4012406 04226 9	40 m

361 10 x 70 mm

Aluminium-Clips-Sockelleiste

Aluminium.
Bodenabdeckbreite 10 mm.
Inklusive Clips (2,5 Stück/m).
Auf Anfrage biegsam.

Aluminium clip skirting board

Aluminium.
Floor covering width 10 mm.
Clips included (2,5 clips/m).
Bendable on request.

r ≥ 30 cm

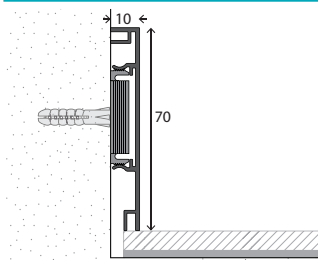
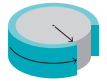

Farbe / colour	cm	SB	Art. Nr. / item no	EAN-Code	VE
silber / silver	400		361 10 11 400	4012406 04579 6	40 m

363 10 x 80 mm

Aluminium-Clips-Sockelleiste

Aluminium.
Bodenabdeckbreite 10 mm.
Inklusive Clips (2,5 Stück/m).
Auf Anfrage biegsam.

Aluminium clip skirting board

Aluminium.
Floor covering width 10 mm.
Clips included (2,5 clips/m).
Bendable on request.

r ≥ 30 cm

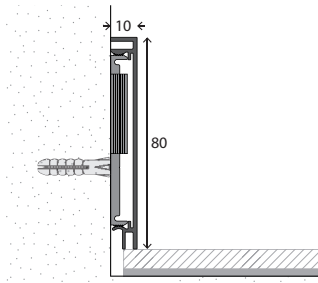
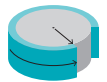

Farbe / colour	cm	SB	Art. Nr. / item no	EAN-Code	VE
silber / silver	400		363 10 11 400	4012406 04580 2	40 m

364 10 x 00 mm

Aluminium-Clips-Sockelleiste

Aluminium.
Bodenabdeckbreite 10 mm.
Inklusive Clips (2,5 Stück/m).
Auf Anfrage biegsam.

Aluminium clip skirting board

Aluminium.
Floor covering width 10 mm.
Clips included (2,5 clips/m).
Bendable on request.

r ≥ 30 cm

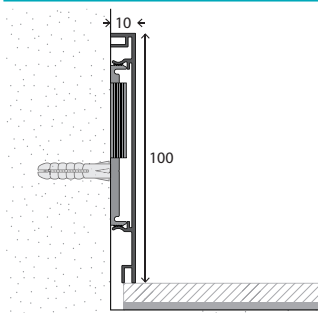
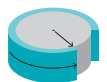

Farbe / colour	cm	SB	Art. Nr. / item no	EAN-Code	VE
silber / silver	400		364 10 11 400	4012406 04581 9	40 m

354 13 x 60 mm

Aluminium-Clips-Sockelleiste

Aluminium.
Bodenabdeckbreite 13 mm.
Inklusive Clips (2,5 Stück/m).
Auf Anfrage biegsam.

Aluminium clip skirting board

Aluminium.
Floor covering width 13 mm.
Clips included (2,5 clips/m).
Bendable on request.

r ≥ 30 cm

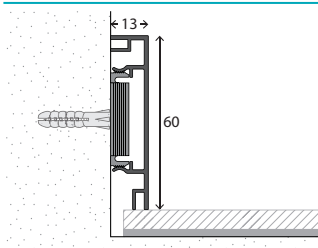
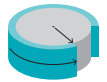

Farbe / colour	cm	SB	Art. Nr. / item no	EAN-Code	VE
silber / silver	400		354 10 11 400	4012406 29782 9	40 m

353 13 x 70 mm

Aluminium-Clips-Sockelleiste

Aluminium.
Bodenabdeckbreite 13 mm.
Inklusive Clips (2,5 Stück/m).
Auf Anfrage biegsam.

Aluminium clip skirting board

Aluminium.
Floor covering width 13 mm.
Clips included (2,5 clips/m).
Bendable on request.

r ≥ 30 cm

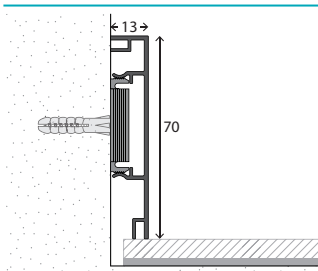
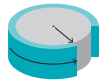

Farbe / colour	cm	SB	Art. Nr. / item no	EAN-Code	VE
silber / silver	400		353 10 11 400	4012406 04582 6	40 m

355 13 x 80 mm

Aluminium-Clips-Sockelleiste

Aluminium.
Bodenabdeckbreite 13 mm.
Inklusive Clips (2,5 Stück/m).
Auf Anfrage biegsam.

Aluminium clip skirting board

Aluminium.
Floor covering width 13 mm.
Clips included (2,5 clips/m).
Bendable on request.

r ≥ 30 cm

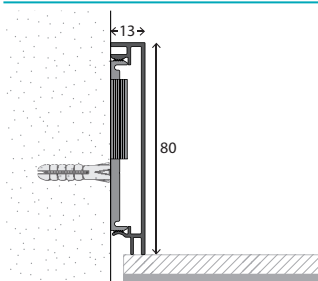
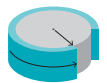

Farbe / colour	cm	SB	Art. Nr. / item no	EAN-Code	VE
silber / silver	400		355 10 11 400	4012406 29783 6	40 m

356 13 x 100 mm

Aluminium-Clips-Sockelleiste

Aluminium.
Bodenabdeckbreite 13 mm.
Inklusive Clips (2,5 Stück/m).
Auf Anfrage biegsam.

Aluminium clip skirting board

Aluminium.
Floor covering width 13 mm.
Clips included (2,5 clips/m).
Bendable on request.

r ≥ 40 cm

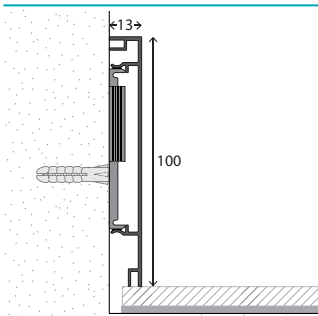
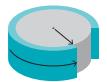

Farbe / colour	cm	SB	Art. Nr. / item no	EAN-Code	VE
silber / silver	400		356 10 11 400	4012406 29784 3	40 m

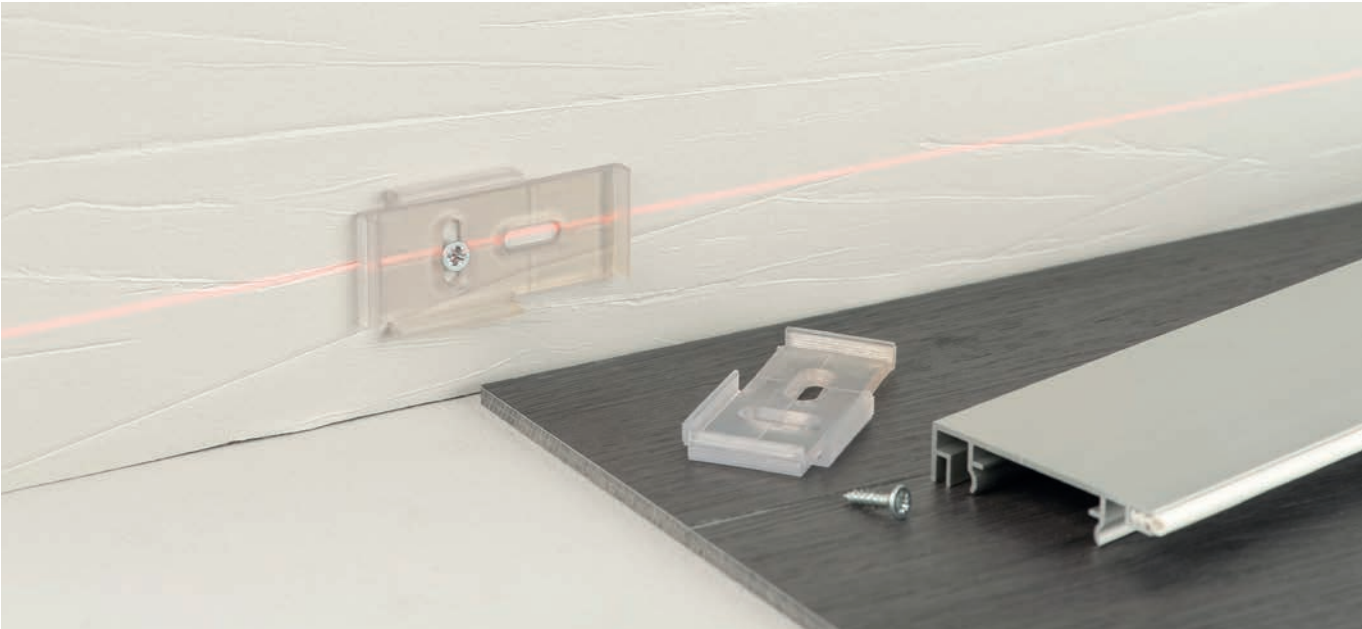

357 13 x 80 mm

LED-Sockelleiste

Aluminium.
Bodenabdeckbreite 13 mm.
Inklusive Clips (2,5 Stück/m).
Inklusive LED-Diffusor.
Auf Anfrage biegsam.

LED-Skirting board

Aluminium.
Floor covering width 13 mm.
Clips included (2,5 clips/m).
LED diffuser included.
Bendable on request.

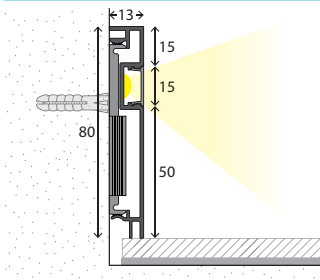

Farbe / colour	cm	SB	Art. Nr. / item no	EAN-Code	VE
silber / silver	400		357 10 11 400	4012406 29785 0	40 m

35420 15 mm

LED-Diffusor

PET, Translucent.

LED diffuser

PET, translucent.

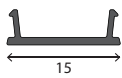

Farbe / colour	cm	SB	Art. Nr. / item no	EAN-Code	VE
transluzent / translucent	400		354 20 00 400	4012406 29761 4	40 m
	250		354 20 00 250	4012406 29762 1	8



358 13 x 80 mm

LED-Sockelleiste

Aluminium.
Bodenabdeckbreite 13 mm.
Inklusive Clips (2,5 Stück/m).
Indirekte Beleuchtung.
Auf Anfrage biegsam.

LED-Skirting board

Aluminium.
Floor covering width 13 mm.
Clips included (2,5 clips/m).
Indirect illumination.
Bendable on request.

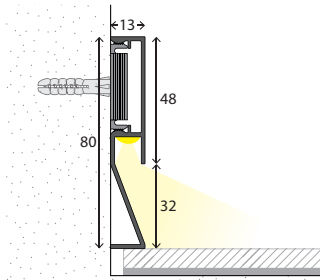

Farbe / colour	cm	SB	Art. Nr. / item no	EAN-Code	VE
silber / silver	400		358 10 11 400	4012406 29786 7	40 m

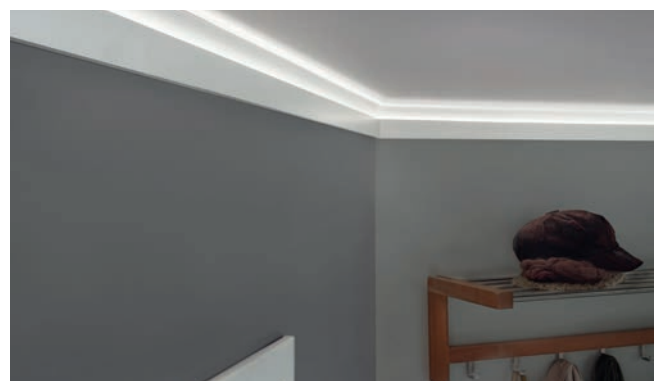

353-364

25 x 25 cm

Innenecke für Sockelleisten 353-364

Aluminium, Schenkellänge 25 cm.
Formstück vormontiert, 90°. Zur Befestigung mit Sockelleistenclips.
Weitere Winkel zwischen 45° und 180° auf Anfrage.

Inner corner for skirting boards 353-364

Aluminium, flank length 25 cm.
Fitting, pre-assembled, 90°. For fastening with clips.
Other angles between 45° and 180° on request.

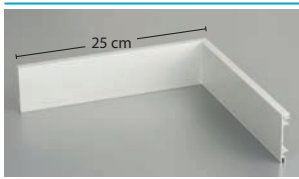

Farbe / colour	Sockelleiste / Skirting	mm	Art. Nr. / item no	EAN-Code	VE
silber / silver	359	10 x 60	359 01 11 000	4012406 03463 9	1
schwarz / black (RAL 9005)	359	10 x 60	359 01 32 000	4012406 04227 6	1
silber / silver	361	10 x 70	361 01 11 000	4012406 04583 3	1
silber / silver	363	10 x 80	363 01 11 000	4012406 04584 0	1
silber / silver	364	10 x 100	364 01 11 000	4012406 04585 7	1
silber / silver	354	13 x 60	354 01 11 000	4012406 03464 6	1
silber / silver	353	13 x 70	353 01 11 000	4012406 04586 4	1
silber / silver	355	13 x 80	355 01 11 000	4012406 03465 3	1
silber / silver	356	13 x 100	356 01 11 000	4012406 03466 0	1
silber / silver	357	13 x 80	357 01 11 000	4012406 03467 7	1
silber / silver	358	13 x 80	358 01 11 000	4012406 03468 4	1

353-364

25 x 25 cm

Außenecke für Sockelleisten 353-364

Aluminium, Schenkellänge 25 cm.
Formstück vormontiert, 90°. Zur Befestigung mit Sockelleistenclips.
Weitere Winkel zwischen 45° und 180° auf Anfrage.

Outer corner for skirting boards 353-364

Aluminium, flank length 25 cm.
Fitting, pre-assembled, 90°. For fastening with clips.
Other angles between 45° and 180° on request.

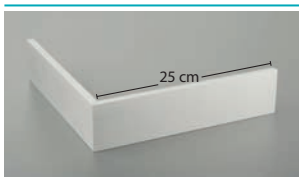

Farbe / colour	Sockelleiste / Skirting	mm	Art. Nr. / item no	EAN-Code	VE
silber / silver	359	10 x 60	359 02 11 000	4012406 03469 1	1
schwarz / black (RAL 9005)	359	10 x 60	359 02 32 000	4012406 04228 3	1
silber / silver	361	10 x 70	361 02 11 000	4012406 04587 1	1
silber / silver	363	10 x 80	363 02 11 000	4012406 04588 8	1
silber / silver	364	10 x 100	364 02 11 000	4012406 04589 5	1
silber / silver	354	13 x 60	354 02 11 000	4012406 03470 7	1
silber / silver	353	13 x 70	353 02 11 000	4012406 04590 1	1
silber / silver	355	13 x 80	355 02 11 000	4012406 03471 4	1
silber / silver	356	13x100	356 02 11 000	4012406 03472 1	1
silber / silver	357	13 x 80	357 02 11 000	4012406 03473 8	1
silber / silver	358	13 x 80	358 02 11 000	4012406 03474 5	1

353-364

2 mm

Endstück für Sockelleisten 353-364

Aluminium, 2 mm stark. Zum Aufkleben auf die Schnittkante.

End cap for skirting boards 353-364

Aluminium, 2 mm thick. For gluing on the cutting line.



Farbe / colour	Sockelleiste / Skirting	mm	Art. Nr. / item no	EAN-Code	VE
silber / silver	359	10 x 60	359 03 11 000	4012406 03475 2	1
schwarz / black (RAL 9005)	359	10 x 60	359 03 32 000	4012406 04229 0	1
silber / silver	361	10 x 70	361 03 11 000	4012406 04591 8	1
silber / silver	363	10 x 80	363 03 11 000	4012406 04592 5	1
silber / silver	364	10 x 100	364 03 11 000	4012406 04593 2	1
silber / silver	354	13 x 60	354 03 11 000	4012406 03476 9	1
silber / silver	353	13 x 70	353 03 11 000	4012406 04594 9	1
silber / silver	355, 357, 358	13 x 80	355 03 11 000	4012406 03477 6	1
silber / silver	356	13x100	356 03 11 000	4012406 03478 3	1

35400

64 x 32 mm

Sockelleisten-Clips

Kunststoff. Geeignet für Aluminium-Sockelleisten 353-364.

Clips for wall skirting boards

PVC. Suitable for skirting boards no. 353-364.



Farbe / colour	mm	SB	Art. Nr. / item no	EAN-Code	VE
transparent / transparent	64 x 32		354 00 00 000	4012406 29788 1	100

35410

4 x 9 mm

Schlauchdichtung

Geeignet für Aluminium-Sockelleisten mit Nuten
(Nr. 353-357 und 359-364).

Sealing lip

Suitable for skirting boards with sealing lip grooves
(no. 353-357 and 359-364).

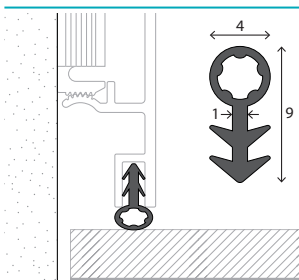

Farbe / colour	L (m)	SB	Art. Nr. / item no	EAN-Code	VE
transparent / transparent	100		354 10 01 000	4012406 29789 8	100
weiß / white	100		354 10 02 000	4012406 29790 4	100
hellgrau / light-grey	100		354 10 03 000	4012406 29791 1	100

375 5 x 60 mm

Winkel-Sockelleiste

Aluminium.
Für Belagstärken bis 3,5 mm.
Mit Wendefunktion.
Auf Anfrage biegsam.

Angle skirting

Aluminium.
For floorings up to 3.5 mm.
With reversing function.
Bendable on request.

r ≥ 20 cm

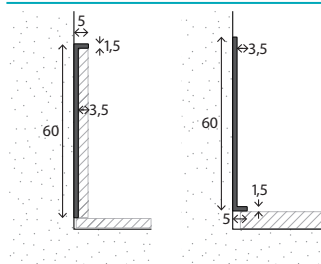

Farbe / colour	cm	SB	Art. Nr. / item no	EAN-Code	VE
silber / silver	500		375 10 11 500	4012406 03485 1	50 m
	250	S	375 10 11 250	4012406 03479 0	10

376 8 x 60 mm

Winkel-Sockelleiste

Aluminium.
Für Belagstärken bis 6,5 mm.
Mit Wendefunktion.
Auf Anfrage biegsam.

Angle skirting

Aluminium.
For floorings up to 6.5 mm.
With reversing function.
Bendable on request.

r ≥ 20 cm

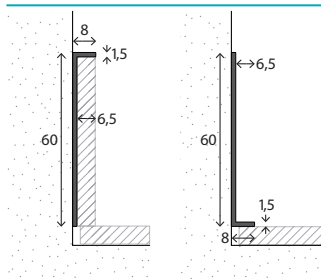

Farbe / colour	cm	SB	Art. Nr. / item no	EAN-Code	VE
silber / silver	500		376 10 11 500	4012406 03487 5	50 m
	250	S	376 10 11 250	4012406 03481 3	10

389 9,5 x 60 mm

Winkel-Sockelleiste

Aluminium.
Für Belagstärken bis 8 mm.
Mit Wendefunktion.
Auf Anfrage biegsam.

Angle skirting

Aluminium.
For floorings up to 8 mm.
With reversing function.
Bendable on request.

r ≥ 30 cm

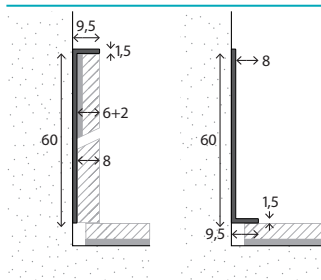

Farbe / colour	cm	SB	Art. Nr. / item no	EAN-Code	VE
silber / silver	500		389 10 11 500	4012406 04022 7	50 m
	250	S	389 10 11 250	4012406 04023 4	10

377 14,5 x 60 mm

Winkel-Sockelleiste

Aluminium.
Für Belagstärken bis 13 mm.
Mit Wendefunktion.
Auf Anfrage biegsam.

Angle skirting

Aluminium.
For floorings up to 13 mm.
With reversing function.
Bendable on request.

r ≥ 30 cm

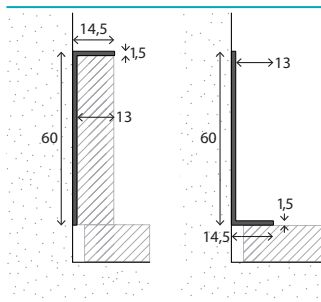

Farbe / colour	cm	SB	Art. Nr. / item no	EAN-Code	VE
silber / silver	500		377 10 11 500	4012406 03489 9	50 m
	250	S	377 10 11 250	4012406 03483 7	10

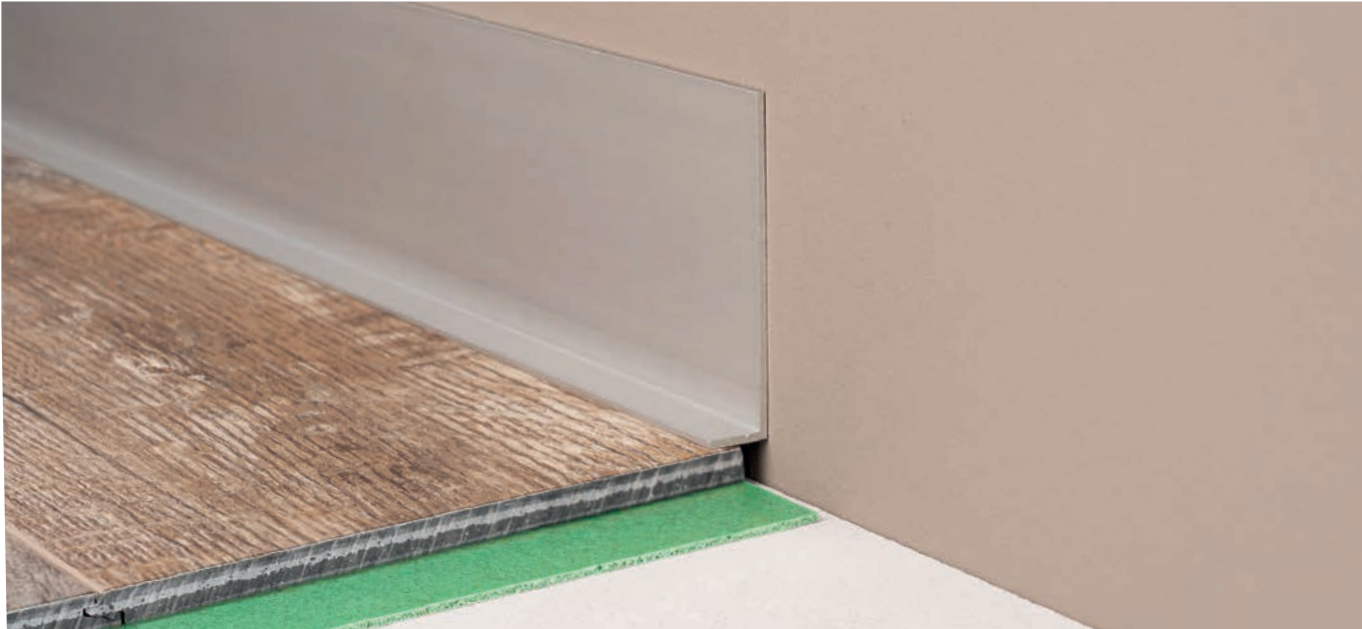

386 5 x 100 mm

Winkel-Sockelleiste
 Aluminium.
 Für Belagstärken bis 3,5 mm.
 Mit Wendefunktion.
 Auf Anfrage biegsam.

Angle skirting
 Aluminium.
 For floorings up to 3.5 mm.
 With reversing function.
 Bendable on request.

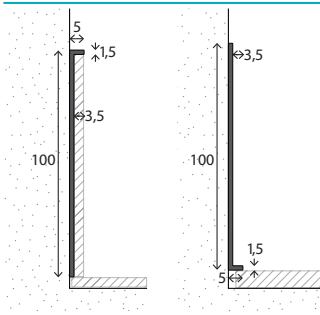
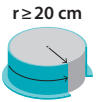

Farbe / colour	cm	SB	Art. Nr. / item no	EAN-Code	VE
silber / silver	500		386 10 11 500	4012406 03491 2	50 m

387 8 x 100 mm

Winkel-Sockelleiste
 Aluminium.
 Für Belagstärken bis 6,5 mm.
 Mit Wendefunktion.
 Auf Anfrage biegsam.

Angle skirting
 Aluminium.
 For floorings up to 6.5 mm.
 With reversing function.
 Bendable on request.

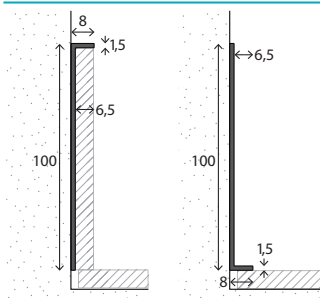
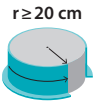

Farbe / colour	cm	SB	Art. Nr. / item no	EAN-Code	VE
silber / silver	500		387 10 11 500	4012406 03493 6	50 m

388 14,5 x 100 mm

Winkel-Sockelleiste
 Aluminium.
 Für Belagstärken bis 13 mm.
 Mit Wendefunktion.
 Auf Anfrage biegsam.

Angle skirting
 Aluminium.
 For floorings up to 13 mm.
 With reversing function.
 Bendable on request.

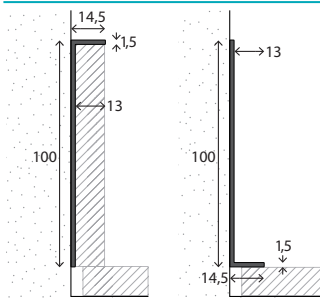
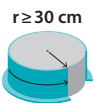

Farbe / colour	cm	SB	Art. Nr. / item no	EAN-Code	VE
silber / silver	500		388 10 11 500	4012406 03495 0	50 m

390 19 x 60 mm

Winkel-Sockelleiste
 Aluminium.
 Für Belagstärken bis 16 mm.
 Ungelocht

Angle skirting
 Aluminium.
 For floor coverings up to 16 mm.
 Unperforated.

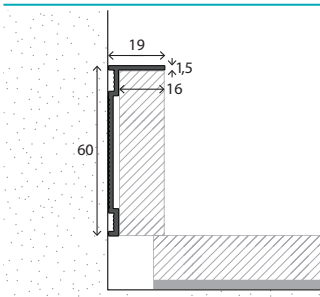

Farbe / colour	cm	SB	Art. Nr. / item no	EAN-Code	VE
silber / silver	400		390 10 11 400	4012406 04026 5	20 m
schwarz / black (RAL 9005)	400		390 10 32 400	4012406 04230 6	20 m

391 5,3 x 82 mm

Hohlkehl-Sockelleiste

Aluminium.
 Ungelocht.
 Für Beläge bis 3,5 mm.
 Für nahtlose Übergänge vom Boden zur Wand.
 Für hygienisch sensible Bereiche, z.B. Krankenhäuser.

Cove and cap skirtings

Aluminium.
 Unperforated.
 For floor coverings up to 3.5 mm.
 For seamless transitions between floor and wall.
 For hygienically sensitive areas, e.g. hospitals.

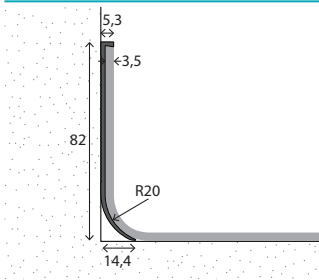

Farbe / colour	cm	SB	Art. Nr. / item no	EAN-Code	VE
Aluminium natur / aluminium natural	400		391 10 06 400	4012406 04030 2	40 m

392 5,5 x 102 mm

Hohlkehl-Sockelleiste

Aluminium.
 Ungelocht.
 Für Beläge bis 3,5 mm.
 Für nahtlose Übergänge vom Boden zur Wand.
 Für hygienisch sensible Bereiche, z.B. Krankenhäuser.

Cove and cap skirtings

Aluminium.
 Unperforated.
 For floor coverings up to 3.5 mm.
 For seamless transitions between floor and wall.
 For hygienically sensitive areas, e.g. hospitals.

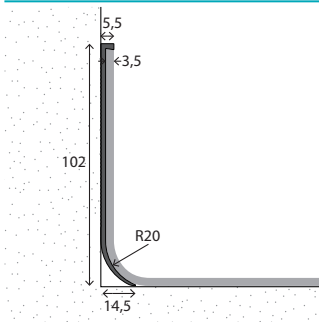

Farbe / colour	cm	SB	Art. Nr. / item no	EAN-Code	VE
Aluminium natur / aluminium natural	400		392 10 06 400	4012406 04030 6	40 m



370 15,3 x 43,5 mm

Reno-Sockelleiste

Aluminium.
Ungelocht.
Für Beläge 2-3 mm.
Zur Abdeckung von Fliesensockeln bis 11 mm Stärke.
Auf Anfrage biegsam.

Renovation skirting

Aluminium.
Unperforated.
For floor coverings 2-3 mm.
For covering ceramic tiles up to 11 mm thick.
Bendable on request.

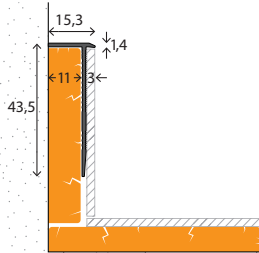
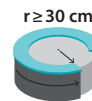

Farbe / colour	cm	SB	Art. Nr. / item no	EAN-Code	VE
silber / silver	300		370 10 11 300	4012406 03030 3	10

369 20,3 x 43,5 mm

Reno-Sockelleiste

Aluminium.
Ungelocht.
Für Beläge 4-8 mm.
Zur Abdeckung von Fliesensockeln bis 11 mm Stärke.

Renovation skirting

Aluminium.
Unperforated.
For floor coverings 4-8 mm.
For covering ceramic tiles up to 11 mm thick.

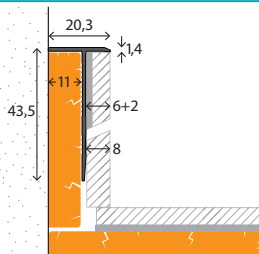

Farbe / colour	cm	SB	Art. Nr. / item no	EAN-Code	VE
silber / silver	300		369 10 11 300	4012406 04020 3	10



911 2 x 60 mm

Flachprofil

Aluminium.
Ungelocht.
Biegsam.

Flat section

Aluminium.
Unperforated.
Bendable.

r ≥ 20 cm

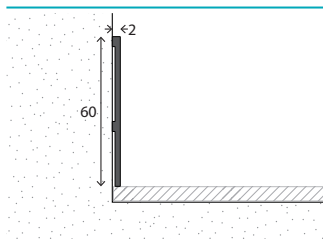
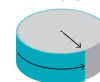

Farbe / colour	cm	SB	Art. Nr. / item no	EAN-Code	VE
silber / silver	300		911 10 11 300	4012406 29795 9	6

915 2 x 100 mm

Flachprofil

Aluminium.
Ungelocht.
Biegsam.

Flat section

Aluminium.
Unperforated.
Bendable.

r ≥ 20 cm

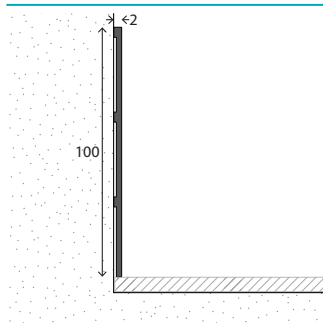
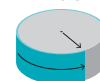

Farbe / colour	cm	SB	Art. Nr. / item no	EAN-Code	VE
silber / silver	300		915 10 11 300	4012406 29796 6	6



378 11 x 60 mm

Aluminium-Sockelleiste mit Einschub

Aluminium.
Für Beläge 2-3 mm.
Breite des einzuschiebenden Belagstreifens: 50 mm.
Bodenabdeckbreite 11 mm.
Ungelocht.
Auf Anfrage biegsam.

Aluminium skirting board with slide-in-unit

Aluminium.
For floor coverings 2-3 mm.
Width of the covering strip: 50 mm.
Floor covering width 11 mm.
Unperforated.
Bendable on request.

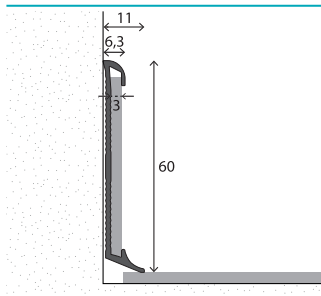
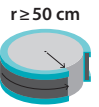

Farbe / colour	cm	SB	Art. Nr. / item no	EAN-Code	VE
silber / silver	400		378 10 11 400	4012406 02458 6	40 m
	270	S	378 20 11 270	4012406 02459 3	10
titan / titan	400		378 10 08 400	4012406 02460 9	40 m
	270	S	378 20 08 270	4012406 02461 6	10

37801 11 x 60 mm

Innenecke für Sockelleiste 378

Aluminium.
1 Stück pro Beutel.

Inner corner for skirting board 378

Aluminium.
1 piece per bag.



Farbe / colour	SB	Art. Nr. / item no	EAN-Code	VE
silber / silver	SB	378 01 11 000	4012406 02462 3	1
titan / titan	SB	378 01 08 000	4012406 02463 0	1

37802 11 x 60 mm

Außenecke für Sockelleiste 378

Aluminium.
1 Stück pro Beutel.

Outer corner for skirting board 378

Aluminium.
1 piece per bag.



Farbe / colour	SB	Art. Nr. / item no	EAN-Code	VE
silber / silver	SB	378 02 11 000	4012406 02464 7	1
titan / titan	SB	378 02 08 000	4012406 02465 4	1

37804 11 x 60 mm

Endstück links für Sockelleiste 378

Aluminium.
1 Stück pro Beutel.

End cap left for skirting board 378

Aluminium.
1 piece per bag.



Farbe / colour	SB	Art. Nr. / item no	EAN-Code	VE
silber / silver	SB	378 04 11 000	4012406 02466 1	1
titan / titan	SB	378 04 08 000	4012406 02467 8	1

37805 11 x 60 mm

Endstück rechts für Sockelleiste 378

Aluminium.
1 Stück pro Beutel.

End cap right for skirting board 378

Aluminium.
1 piece per bag.



Farbe / colour	SB	Art. Nr. / item no	EAN-Code	VE
silber / silver	SB	378 05 11 000	4012406 02468 5	1
titan / titan	SB	378 05 08 000	4012406 02469 2	1



379 13 x 60 mm

Aluminium-Sockelleiste mit Einschub

Aluminium.
Für Beläge 4-5 mm.
Breite des einzuschiebenden Belagstreifens: 50 mm.
Bodenabdeckbreite 13 mm.
Ungelocht.
Auf Anfrage biegsam.

Aluminium skirting board with slide-in-unit

Aluminium.
For floor coverings 4-5 mm.
Width of the covering strip: 50 mm.
Floor covering width 13 mm.
Unperforated.
Bendable on request.

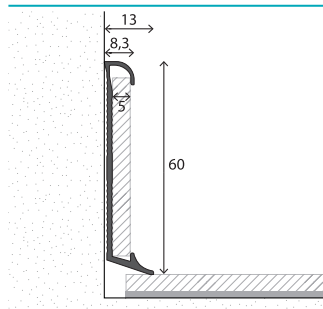
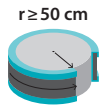

Farbe / colour	cm	SB	Art. Nr. / item no	EAN-Code	VE
silber / silver	400		379 10 11 400	4012406 21057 6	40 m
	270	S	379 20 11 270	4012406 21058 3	10
titan / titan	400		379 10 08 400	4012406 21059 0	40 m
	270	S	379 20 08 270	4012406 21060 6	10

37901 13 x 60 mm

Innenecke für Sockelleiste 379

Aluminium.
1 Stück pro Beutel.

Inner corner for skirting board 379

Aluminium.
1 piece per bag.



Farbe / colour	SB	Art. Nr. / item no	EAN-Code	VE
silber / silver	SB	379 01 11 000	4012406 21061 3	1
titan / titan	SB	379 01 08 000	4012406 21062 0	1

37902 13 x 60 mm

Außenecke für Sockelleiste 379

Aluminium.
1 Stück pro Beutel.

Outer corner for skirting board 379

Aluminium.
1 piece per bag.



Farbe / colour	SB	Art. Nr. / item no	EAN-Code	VE
silber / silver	SB	379 02 11 000	4012406 21063 7	1
titan / titan	SB	379 02 08 000	4012406 21064 4	1

37904 13 x 60 mm

Endstück links für Sockelleiste 379

Aluminium.
1 Stück pro Beutel.

End cap left for skirting board 379

Aluminium.
1 piece per bag.



Farbe / colour	SB	Art. Nr. / item no	EAN-Code	VE
silber / silver	SB	379 04 11 000	4012406 21065 1	1
titan / titan	SB	379 04 08 000	4012406 21066 8	1

37905 13 x 60 mm

Endstück rechts für Sockelleiste 379

Aluminium.
1 Stück pro Beutel.

End cap right for skirting board 379

Aluminium.
1 piece per bag.



Farbe / colour	SB	Art. Nr. / item no	EAN-Code	VE
silber / silver	SB	379 05 11 000	4012406 21067 5	1
titan / titan	SB	379 05 08 000	4012406 21068 2	1



371 11 x 40 mm

Aluminium-Sockelleiste

Aluminium.
Bodenabdeckbreite 11 mm.
Ungelocht.
Auf Anfrage biegsam.

Aluminium skirting board

Aluminium.
Floor covering width 11 mm.
Unperforated.
Bendable on request.

r ≥ 20 cm

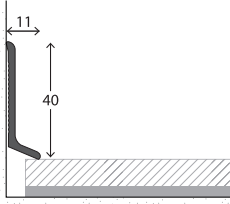
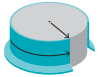

Farbe / colour	cm	SB	Art. Nr. / item no	EAN-Code	VE
silber / silver	400		371 10 11 400	4012406 02470 8	40 m
	270	S	371 20 11 270	4012406 02471 5	10
titan / titan	400		371 10 08 400	4012406 02472 2	40 m
	270	S	371 20 08 270	4012406 02473 9	10

372 11 x 60 mm

Aluminium-Sockelleiste

Aluminium.
Bodenabdeckbreite 11 mm.
Ungelocht.
Auf Anfrage biegsam.

Aluminium skirting board

Aluminium.
Floor covering width 11 mm.
Unperforated.
Bendable on request.

r ≥ 20 cm

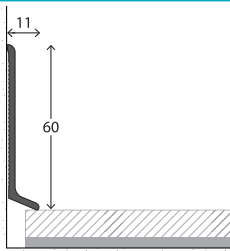
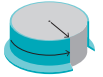

Farbe / colour	cm	SB	Art. Nr. / item no	EAN-Code	VE
silber / silver	400		372 10 11 400	4012406 02474 6	40 m
	270	S	372 20 11 270	4012406 02475 3	10
titan / titan	400		372 10 08 400	4012406 02476 0	40 m
	270	S	372 20 08 270	4012406 02477 7	10

373 11 x 80 mm

Aluminium-Sockelleiste

Aluminium.
Bodenabdeckbreite 11 mm.
Ungelocht.
Auf Anfrage biegsam.

Aluminium skirting board

Aluminium.
Floor covering width 11 mm.
Unperforated.
Bendable on request.

r ≥ 20 cm

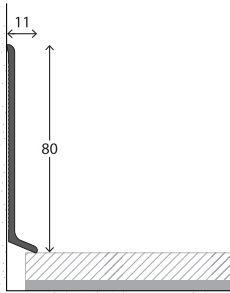
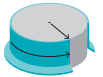

Farbe / colour	cm	SB	Art. Nr. / item no	EAN-Code	VE
silber / silver	400		373 10 11 400	4012406 02478 4	40 m
	270	S	373 20 11 270	4012406 02479 1	10
titan / titan	400		373 10 08 400	4012406 02480 7	40 m
	270	S	373 20 08 270	4012406 02481 4	10

374 11 x 100 mm

Aluminium-Sockelleiste

Aluminium.
Bodenabdeckbreite 11 mm.
Ungelocht.
Auf Anfrage biegsam.

Aluminium skirting board

Aluminium.
Floor covering width 11 mm.
Unperforated.
Bendable on request.

r ≥ 30 cm

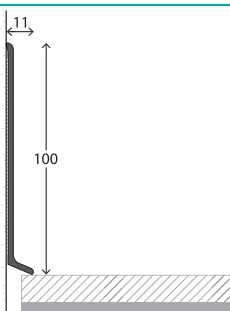
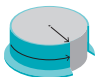

Farbe / colour	cm	SB	Art. Nr. / item no	EAN-Code	VE
silber / silver	400		374 10 11 400	4012406 02482 1	40 m
	270	S	374 20 11 270	4012406 02483 8	10
titan / titan	400		374 10 08 400	4012406 02484 5	40 m
	270	S	374 20 08 270	4012406 02485 2	10

37101-37401

Innenecke für Sockelleisten 371-374

Aluminium.
1 Stück pro Beutel.

Inner corner for skirting boards 371-374

Aluminium.
1 piece per bag.



Farbe / colour	H (mm)	SB	Art. Nr. / item no	EAN-Code	VE
silber / silver	40	SB	371 01 11 000	4012406 02486 9	1
titan / titan	40	SB	371 01 08 000	4012406 02487 6	1
silber / silver	60	SB	372 01 11 000	4012406 02488 3	1
titan / titan	60	SB	372 01 08 000	4012406 02489 0	1
silber / silver	80	SB	373 01 11 000	4012406 02490 6	1
titan / titan	80	SB	373 01 08 000	4012406 02491 3	1
silber / silver	100	SB	374 01 11 000	4012406 02492 0	1
titan / titan	100	SB	374 01 08 000	4012406 02493 7	1

37102-37402

Außenecke für Sockelleisten 371-374

Aluminium.
1 Stück pro Beutel.

Outer corner for skirting boards 371-374

Aluminium.
1 piece per bag.



Farbe / colour	H (mm)	SB	Art. Nr. / item no	EAN-Code	VE
silber / silver	40	SB	371 02 11 000	4012406 02494 4	1
titan / titan	40	SB	371 02 08 000	4012406 02495 1	1
silber / silver	60	SB	372 02 11 000	4012406 02496 8	1
titan / titan	60	SB	372 02 08 000	4012406 02497 5	1
silber / silver	80	SB	373 02 11 000	4012406 02498 2	1
titan / titan	80	SB	373 02 08 000	4012406 02499 9	1
silber / silver	100	SB	374 02 11 000	4012406 02500 2	1
titan / titan	100	SB	374 02 08 000	4012406 02501 9	1

37103-37403

Verbinder für Sockelleisten 371-374

Aluminium.
1 Stück pro Beutel.

Profile ties for skirting boards 371-374

Aluminium.
1 piece per bag.



Farbe / colour	H (mm)	SB	Art. Nr. / item no	EAN-Code	VE
silber / silver	40	SB	371 03 11 000	4012406 02502 6	1
titan / titan	40	SB	371 03 08 000	4012406 02503 3	1
silber / silver	60	SB	372 03 11 000	4012406 02504 0	1
titan / titan	60	SB	372 03 08 000	4012406 02505 7	1
silber / silver	80	SB	373 03 11 000	4012406 02506 4	1
titan / titan	80	SB	373 03 08 000	4012406 02507 1	1
silber / silver	100	SB	374 03 11 000	4012406 02508 8	1
titan / titan	100	SB	374 03 08 000	4012406 02509 5	1

37104-37404

Endstücke links für Sockelleisten 371-374

Aluminium.
1 Stück pro Beutel.

End caps left for skirting boards 371-374

Aluminium.
1 piece per bag.



Farbe / colour	H (mm)	SB	Art. Nr. / item no	EAN-Code	VE
silber / silver	40	SB	371 04 11 000	4012406 02510 1	1
titan / titan	40	SB	371 04 08 000	4012406 02511 8	1
silber / silver	60	SB	372 04 11 000	4012406 02512 5	1
titan / titan	60	SB	372 04 08 000	4012406 02513 2	1
silber / silver	80	SB	373 04 11 000	4012406 02514 9	1
titan / titan	80	SB	373 04 08 000	4012406 02515 6	1
silber / silver	100	SB	374 04 11 000	4012406 02516 3	1
titan / titan	100	SB	374 04 08 000	4012406 02517 0	1

37105-37405

Endstücke rechts für Sockelleisten 371-374

Aluminium.
1 Stück pro Beutel.

End caps right for skirting boards 371-374

Aluminium.
1 piece per bag.



Farbe / colour	H (mm)	SB	Art. Nr. / item no	EAN-Code	VE
silber / silver	40	SB	371 05 11 000	4012406 02518 7	1
titan / titan	40	SB	371 05 08 000	4012406 02519 4	1
silber / silver	60	SB	372 05 11 000	4012406 02520 0	1
titan / titan	60	SB	372 05 08 000	4012406 02521 7	1
silber / silver	80	SB	373 05 11 000	4012406 02522 4	1
titan / titan	80	SB	373 05 08 000	4012406 02523 1	1
silber / silver	100	SB	374 05 11 000	4012406 02524 8	1
titan / titan	100	SB	374 05 08 000	4012406 02525 5	1

380 11 x 22 mm

Sockelprofil

Aluminium.
Für Beläge 2-3 mm.
Bodenabdeckbreite 11 mm.
Ungelocht.
Auf Anfrage biegsam.

Skirting section

Aluminium.
For floor coverings 2-3 mm.
Floor covering width 11 mm.
Unperforated.
Bendable on request.

r ≥ 40 cm

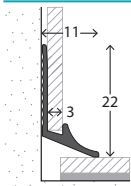
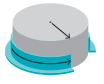

Farbe / colour	cm	SB	Art. Nr. / item no	EAN-Code	VE
silber / silver	250		380 10 11 250	4012406 02531 6	10
Edelstahl matt / stainless steel matt	250		380 10 14 250	4012406 02533 0	10

381 13 x 22 mm

Sockelprofil

Aluminium.
Für Beläge 4-5 mm.
Bodenabdeckbreite 13 mm.
Ungelocht.
Auf Anfrage biegsam.

Skirting section

Aluminium.
For floor coverings 4-5 mm.
Floor covering width 13 mm.
Unperforated.
Bendable on request.

r ≥ 50 cm

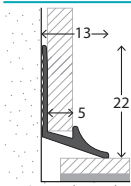
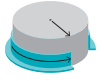

Farbe / colour	cm	SB	Art. Nr. / item no	EAN-Code	VE
silber / silver	250		381 10 11 250	4012406 21074 3	10
Edelstahl matt / stainless steel matt	250		381 10 14 250	4012406 21076 7	10

384 15 x 60 mm

Edelstahl-Sockelleiste

Bodenabdeckbreite 15 mm.
Ungelocht.

Stainless steel skirting board

Floor covering width 15 mm.
Unperforated.

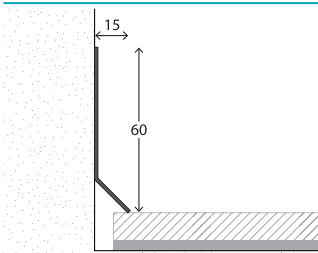

Farbe / colour	cm	SB	Art. Nr. / item no	EAN-Code	VE
Edelstahl gebürstet / stainless steel brushed	250	S	384 10 02 250	4012406 27768 5	10

385 15 x 80 mm

Edelstahl-Sockelleiste

Bodenabdeckbreite 15 mm.
Ungelocht.

Stainless steel skirting board

Floor covering width 15 mm.
Unperforated.

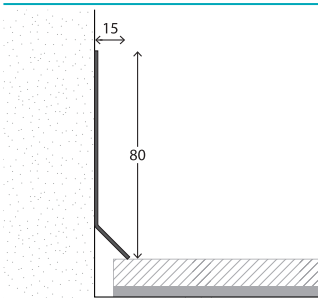

Farbe / colour	cm	SB	Art. Nr. / item no	EAN-Code	VE
Edelstahl gebürstet / stainless steel brushed	250	S	385 10 02 250	4012406 27769 2	10

Notizen Notes



Carl Prinz GmbH & Co. KG
Fußbodentechnik

Verwaltung / Produktion
von-Monschaw-Straße 5
D-47574 Goch

T +49 2823 9703-0
F +49 2823 9703-99
service@carlprinz.de

Logistikzentrum / Versand
Siemensstraße 62
D-47574 Goch

T +49 2823 9326-0
F +49 2823 9703-99

www.carlprinz.de



[instagram.com/
CarlPrinzGmbH](https://www.instagram.com/CarlPrinzGmbH)



[facebook.com/
CarlPrinzProfile](https://www.facebook.com/CarlPrinzProfile)



[youtube.com/
CarlPrinzProfile](https://www.youtube.com/CarlPrinzProfile)



[linkedin.com/
CarlPrinzProfile](https://www.linkedin.com/CarlPrinzProfile)



Starke Verbindung
Kluge Technik
Strong contacts
Clever technology



4 012406 049206

2023-05-MSL01
899 30 10 359